



Vehicle Crime Detection, Investigation & Prevention

2014 Training Seminar

The Grace Hotel, Sydney, New South Wales
30th March - 1st April, 2014



In association with our Seminar Partners:

- Suncorp Insurance ▪ BAE Systems
- National Motor Vehicle Theft Reduction Council
 - F.I.R.E.S. ▪ DataDot Technology
 - CSI Investigations ▪ KordaMentha
 - Lock-it Systems ▪ McAfee Institute



SEMINAR PARTNERS

The Australasian Branch of the International Association of Auto Theft Investigators (IAATI) is a non-profit organisation. Without the ongoing support of seminar partners each year it would not be possible for the branch to hold the high quality training seminars that the branch is renowned for. The branch is forever grateful for the support of its seminars partners. The branch would like to take this opportunity to acknowledge the following 2014 Seminar Partners:

Platinum Partners:



Gold Partners:



Silver Partner:



Bronze Partners:



Exhibitors:

- DataDot Technology
- CARS - Comprehensive Auto-theft Research System



CONTENTS

Welcome to Sydney	4
Australasian Branch Committee	5
General Information	6
Venue Floor Plan	7
Seminar Program.....	9
Sunday 30 March	9
Monday 31 March	9
Tuesday 1 April.....	12
Speaker Profiles	15
Accreditation Program.....	26
Seminar Supporters	27
Before you go, don't forget.....	30



WELCOME TO SYDNEY

On behalf of the Australasian Branch committee I would like to welcome you to our 21st Annual Training Seminar here in Sydney, New South Wales. In particular I would like to welcome the many new members attending their first IAATI seminar and acknowledge the ongoing support of the Australian members who have travelled to Sydney for this training seminar. Please make yourself known to myself and your fellow IAATI members.

I would also like to extend a warm welcome to our international keynote speakers - John Sargent, Director, MetLife (USA) and Ben Kasic, Canadian National Insurance Crime Service. In addition I would also like to welcome all our other speakers who have generously donated their valuable time to present at this seminar.

This year you will notice that we have included two pre-recorded presentations on Tuesday. While our desire is always to try and have the presenters live at the seminar, the costs of flying out and hosting international speakers is quite high. In order to maintain the level of international content within the seminar and fresh topics we are trialling these two pre-recorded presentations at this seminar. Unfortunately the time differences also made it difficult to organise a live link with these presenters. Despite this both Nick Mayell and Joshua McAfee are both highly regarded in their respective fields and are expert trainers. I am confident that you will benefit from viewing their presentations.

I can assure you there has been extensive work undertaken to ensure everything runs smoothly and the contents provide a good mixture of interesting and informative material. In this regard I would like to express my sincere thanks to the branch's Committee members who have worked tirelessly to make this seminar happen.

In planning these seminars, we are consistently aware of the uniquely diverse membership of the Australasian Branch. Unlike many of the other branches which are dominated by law enforcement our membership consists of a unique blend of police personnel (investigators, forensic officers, intelligence analysts), insurance personnel (investigators, claims managers, fraud specialists, analysts), registration personnel (vehicle inspectors, policy staff), academics and researchers, crime prevention officers, forensic locksmiths, motoring club representatives, private investigators, vehicle manufacturers and those involved in the development of vehicle security systems.

This diverse membership while creating challenges for the development of a balanced seminar program, does however, give delegates the opportunity to mix and learn from others with slightly different skill and knowledge sets. I encourage you to interact with your colleagues as much as possible during the next few days.

Staging these annual seminars is a difficult and time consuming task but one that can prove extremely beneficial when they meet the needs and expectations of the delegates. To ensure that future seminars are as beneficial as possible I seek your assistance in two areas.

Firstly, we require your feedback as to what you want to see and do at the next seminar. To facilitate this I encourage you to complete the web based survey that you will receive in the next few weeks. This is your opportunity to tell us what aspects of this seminar you liked and what aspects you would like changed for 2015. It is only through this type of feedback that we can tailor our seminar to meet your requirements.

Secondly, I would encourage you to consider offering your services to the branch. This can be either by assisting in the future seminars and training sessions, by nominating to stand for the branch committee or by sharing information and experiences with your colleagues through the Association's newsletters or the Branch website



GENERAL INFORMATION

Mobile phones

As a courtesy to speakers and other delegates please turn off or mute all mobile phones before entering any conference session or the seminar dinner.

Name badges

All delegates will be given a name badge on registration. For security reasons, we ask that all delegates wear their name badge at all times. This name badge is your official entrance pass to all sessions, morning & afternoon tea's, lunches, the President's reception and the Seminar dinner.

Presentations

Where the speaker has provided permission for their presentation to be recorded and/or provided to members then copies of their presentations will be may available on the Australasian Branch website within one week of the seminar. Naturally some of the material presented during the seminar may be sensitive and will not be provided on the branch website. In these cases please respect the presenters wishes and do not disclose the information they have presented.

President's Reception

The President's reception will be a held from 6- 8 pm on Sunday 30 March on the 12th floor Alkira Rooftop Terrace. The reception is an informal event for delegates to meet and renew friendships prior to the formal start of the Seminar. Attire is casual.

Questions to presenters

If time permits it is the intention that delegates will be given an opportunity to ask a limited number of questions to each speaker at the end of their presentation. However, to be fair to subsequent speakers, we will endeavour to stick as closely as possible to the published timetable. Therefore, if at the end of the scheduled time of each presentation, there is not time for questions, delegates are asked to contact the speaker during the next available refreshment break rather than delay the next scheduled speaker.

Seminar and Awards Dinner

The Seminar dinner will be held on Monday night with 30 minutes of pre dinner drinks at 7.00 pm and the dinner commencing at 7.30 pm. The evening will also include the announcements and presentations of the 2013 Branch Awards. This is a special evening and attire is formal.

Session start times

Delegates are asked to be seated by the allocated start times as sessions will run according to the printed schedule. Your attention is particularly drawn to the start time of 8:30 am each day.

Speakers

Please contact a committee member or the staff on the registration desk asap if you have a PowerPoint presentation so it can be loaded and tested well in advance of your session.

Special Dietary Requirements

If any delegate has special dietary requirements not recorded on their registration form can you please contact a committee member or the staff at the registration desk as soon as possible so the hotel catering staff can be notified.



VENUE FLOOR PLAN

The President's reception will be held on the Alkira Rooftop Terrace commencing at 6.00pm on Sunday 30 March. The classroom presentations and awards dinner will be held in the Wilarra to Kirralaa Rooms 1-4 on level 2. Monday's and Tuesday's lunches will be served in the Grace Brasserie Restaurant on level 2

Level 2

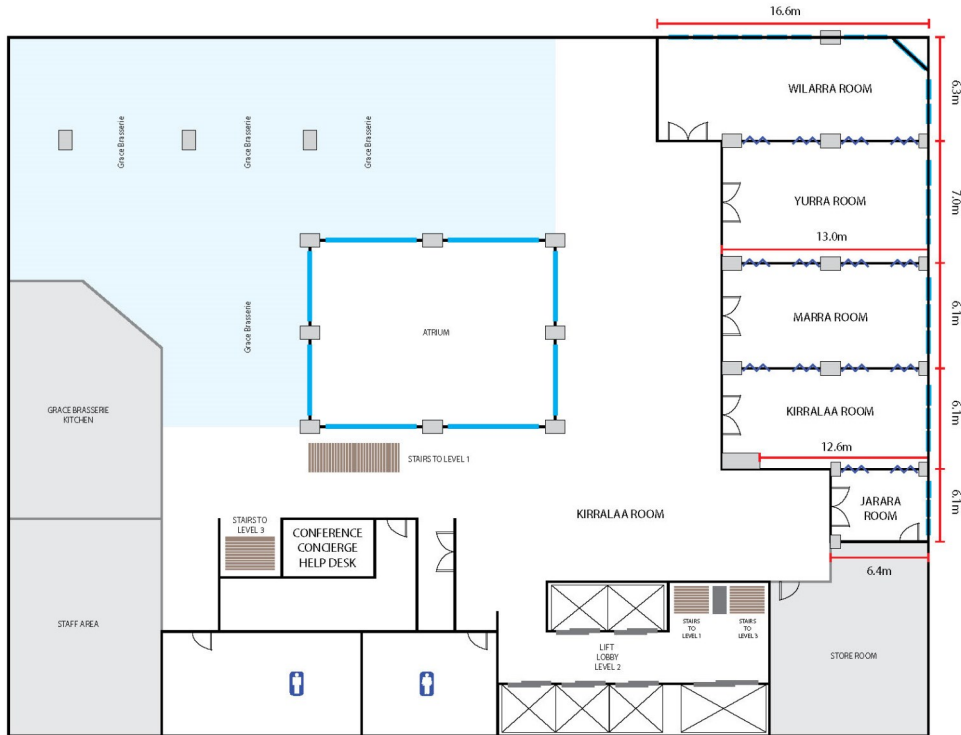

Rooftop Terrace

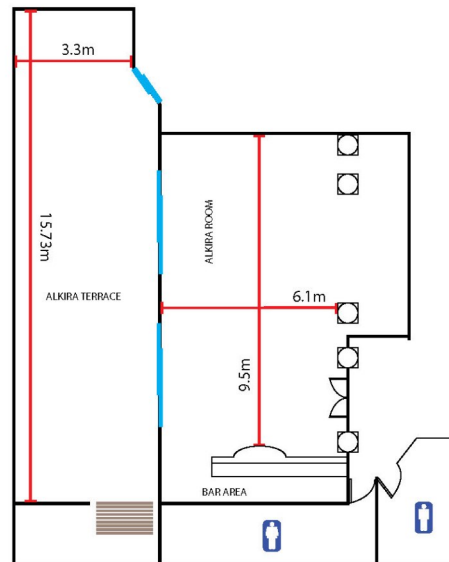



SUNCORP INSURANCE PROUDLY SUPPORTING VEHICLE CRIME REDUCTION INITIATIVES IN AUSTRALIA.

Vehicle theft and auto crimes have a significant impact on the Australian insurance industry and Suncorp Insurance is determined to work closely with law enforcement bodies to address these issues. The International Association of Auto Theft Investigators, Australasian Branch training seminar brings together major Insurers, law enforcement bodies, manufacturers and other industry professionals who are involved in the detection, investigation and reduction of vehicle theft and auto crime. Suncorp Insurance is delighted to be the Platinum Sponsor of the Australasian Branch's 21st Annual Training Seminar.

VISIT YOUR LOCAL BRANCH

THE MUST-HAVE
QUEENSLAND INSURANCE
FOR ALL THAT I HAVE

13 11 55

SUNCORP
Insurance

Insurance issued by AAI Limited ABN 48 005 297 807 trading as Suncorp Insurance. Please read the Product Disclosure Statement before deciding to buy this product. BSUN7832



CONFERENCE PROGRAM

SUNDAY 30TH MARCH

5.30 pm. Registration Desk Opens

6.00 pm President's Reception

Alkira Rooftop Terrace

8.00 pm Close

MONDAY 31ST MARCH

8.30 am to 10.20 am Session 1

8.30 am Welcome
Mark Bennedick, Australasian Branch President & International Director, IAATI

8.40 am "Car Theft in Australia – Where Have We Come From? – Where Are We Going?"
Mr Ray Carroll, Executive Director, National Motor Vehicle Theft Reduction Council

10.20 am to 10.45 am Morning tea

9.20 am "Motor Vehicle Theft in the USA"
John Sargent, Director,
Special Investigation Unit, MetLife (USA)

10.45 am to 12.30 pm Session 2

10.45 am Official opening
Deputy Commissioner Nick Kaldas, New South Wales Police

11.00 am "Strike Force Adderton"
Det. Senior Constable Matt Taylor, New South Wales Police

12.30 pm to 1.20 pm Lunch

supporting investigations - innovative uses of National
DataTraceDNA"

Chris Stott, Executive Director, DataDot Technology

11.55 am "DataDot Technologies
Registers, DataDotDNA and
(Asia) Pte. Ltd.



MONDAY 31ST MARCH

1.20 pm to 3.35 pm Session 3

1.20 pm "An introduction to Canadian National Insurance Crime Services 'CANATICS' and detecting fraud through analytics"

Ben Kosic, President and CEO, Canadian National Insurance Crime Services

2.05 pm "Cyber Crime"

Dr Hugh McDermott, Senior Lecturer in Law Enforcement, Charles Sturt University

2.50 pm "Motor vehicle insurance fraud"

Mr Chris Loane, Manager Motor Investigations GI, Suncorp Group

3.35 pm to 3.55 pm Afternoon tea

3.55 pm to 5.10 pm Session 4

3.55 pm "IFBA fraud prevention and detection database"

Mr Laurie Ratz, Special Risks Manager, Insurance Council of Australia

4.40 pm Australasian Branch Annual General Meeting

7.00 pm to 11.000 pm Seminar Dinner

7.30 pm Seminar Dinner & Australasian Branch Awards Presentations

7.00 pm Pre Dinner Drinks

11.00 pm Close

PROTECT YOUR BUSINESS AND CUSTOMERS FROM CLAIMS FRAUD.

OUR NETREVEAL® SOLUTION HAS REVOLUTIONISED THE DETECTION AND PREVENTION OF FRAUD AND ORGANISED CRIME.

- **Enhance your profitability, improve customer satisfaction and reduce claims spend**
- **Real-time risking of claims and networks through the claims lifecycle**
- **Investment typically recovered within a number of weeks with ROI of 20:1**



For further information please contact 02 9255 0400
or apcommunications@baesystems.com.

Visit www.baesystems.com/ai



TUESDAY 1st APRIL

8.30 am to 10.15 am Session 5

8.30 am "Social Media Investigations" (Pre-recorded presentation)
Joshua McAfee, CEO, McAfee Institute

9.30 am "TBA"
Les Fuller, Maxim Forensic Locksmith Services

10.15 am to 10.35 am Morning tea

10.35 am to 12.30 pm Session 6

10.35 am "Global insurance fraud trends and innovative approaches to detecting fraud"
Steve Clark, Global Product Manger Financial Crime Solutions, BAE Systems

11.05 am "Walking the Tightrope – Solicitors Conflicts in Claims Investigation and Litigation"
David Courtenay, Courtenay & Co Solicitors

12.30 pm to 1.20 pm Lunch

KordaMentha

11.50 am "Metadata and the art of digital investigation"
Nigel Carson, Partner,

1.20 pm to 3.00 pm Session 7

1.20 pm "Operation Ice Pharlap"
Detective Sergeant Renee Kurtz, Queensland Police

1.50 pm "Forensic Collision Reconstruction in the Investigation of Motor Insurance Fraud"
Malcolm Cumberlidge, Forensic Accident Investigation Services

3.00 pm to 3.15 pm Afternoon tea

2.30 pm "Strike Force Granite"
Det. Senior Constable Jason Henderson, Property Crime Squad,
 New South Police



TUESDAY 16TH APRIL

3.15 pm to 4.55 pm

Session 8

3.15 pm "Investigating Vehicle Fires Safely"
Jim Manser, Manser Fire and Marine

3.45 am "UK Heavy Equipment Selective profiling—Roadside Checks"
Nick Mayell, Trainer, Datatag

4.50 pm Seminar Close
Mr Mark Bennedick, IAATI Australasian Branch President

Is there someone missing from the seminar program?

Is there someone really special that you would have liked to have seen present at this year's seminar? If so please send their details to the branch committee so we can try and include them next year.

Likewise, if you have any ideas for workshops, site visits, demonstrations or any type of classroom activity please send us your thoughts to info@iaatiaus.org



IAATI's 62nd Annual International Training Seminar
2014 Seminar Fort Worth, Texas
August 17 - 22, 2014

The 2014 International IAATI seminar will be hosted by the South Central Regional Chapter and held at the Omni Fort Worth Hotel in Fort Worth Texas. For more details please contact the Seminar Director at seminar@iaati.org

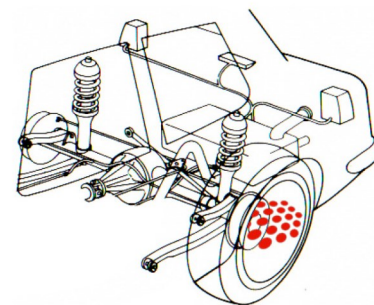

How the Dot has grown (actually, shrunk)

International

Two years on from the commencement of whole-of-vehicle marking with microdots, more than 10 million cars have been marked in 5 countries.

Evolving

Now the Dot is supplemented by DataTrace, a sub-molecular substance for authenticating anything from cigarettes to brake-pads; from alcohol to airbags.



World leading identification and authentication solutions

9/19 Rodborough Road Frenchs Forest NSW 2086 / P 1300 300 829 / F 02 9975 4700
E info@datadotdna.com / www.datadotdna.com



SPEAKER BIOGRAPHIES



Ray Carroll was appointed Executive Director of the NMVTRC when it was formed in 1999. During twenty two years with the Victoria Police, Ray served in various areas of criminal investigation and in his later years of service specialised in crime prevention through his role as manager of the Force's crime prevention bureau.

Ray was the principle author of the National Motor Vehicle Theft Task Force's final report which constituted a comprehensive vehicle theft reduction plan that led to the formation of the Council. Australia's successes in vehicle crime reduction have been recognised internationally and in recent years Ray has consulted on national strategy development in Europe, South Africa, Taiwan and the United States.

Ray's presentation is titled: "Car Theft in Australia – Where Have We Come From? – Where Are We Going?" In absolute numbers the incidence of car theft in Australia is at its lowest point in more than 35 years. Expressed as rates per 1,000 vehicles registered, it is now 80% less than its peak in 1990. While we know some of the factors that have contributed to this dramatic decrease there are many things that we still don't understand about the drivers of crime. By examining the past what can we learn about the future of car crime in Australia and is it possible to maintain this downward trend?



John Sargent is director, Special Investigation Unit (SIU), at MetLife. John was appointed to this position in October 2004 where he is responsible for fraud prevention, detection and investigation. John oversees this function for auto, home, dental, disability, long term care and group life claims.

John joined MetLife in December 1995 as a manager within the SIU. In addition to his role in managing the company's fraud prevention program, he was instrumental in developing fraud detection technology that has increased the program's efficiency. Before joining MetLife, John held various SIU Positions with other insurers and began his professional career as a police officer in Massachusetts.

John is the past Chairman of the New York Alliance Against Insurance Fraud, he is also the Treasurer of the Coalition Against Insurance Fraud, sits on the board of governors for the Insurance Fraud Bureau of Massachusetts, is an advisor to the CEO of the National Insurance Crime Bureau, and is a past board member of the Insurance Committee for Arson Control. John has spoken at numerous national conferences on the topic of insurance fraud.

John's presentation is titled "Motor Vehicle Theft in the USA". In this session he will review theft trends in the USA. He will look at some historical data and discuss prevention methods that have been implemented across the USA to deter this property crime. Case examples and video clips will be used to supplement the presentation.



Deputy Commissioner Nick Kaldas joined the NSW Police Force in 1981. His career spans a number of areas primarily in major crime investigations, Homicide, Armed Robbery, Major Drug investigations, Counter Terrorism and covert operations.

Among other major investigations, he led the high profile investigation into the murder of a Member of Parliament, John NEWMAN, resulting in the conviction and life sentence of Phuong Canh NGO for what the Court described as Australia's first political assassination.



In 1999-2000 he established and led the Crime Management Framework for the Olympic Investigations Strike Force. In 2000-2004 he was the Commander, Homicide Squad, State Crime Command.

In January 2004 he was seconded to the Federal Government and deployed to Iraq, initially as Senior Police Adviser, National Operations, then as Deputy Chief Police Adviser to the Iraqi Government, under the Coalition Provisional Authority, Iraq. In 2005 he was again seconded to the Federal Government and redeployed to Iraq to assist with establishing the Iraqi Special Tribunal, (Regime War Crimes, the body tasked with prosecuting Saddam Hussein and his senior cadre of officials).

From 2004-2006 he was the Commander, Gangs Squad, State Crime Command. From 2006-2007 he was the Assistant Commissioner, Counter Terrorism and Special Tactics Command.

In late 2007, he was appointed Deputy Commissioner, Specialist Operations, responsible for Counter Terrorism and Special Tactics, Forensic Services, Special Services Group, State Crime Command, Business Technology Services, Professional Standards Command, Police Prosecutors, and the Operational Communications and Information Command.

In 2009-2010, he took up a 12-month secondment as Chief of Investigations in the Special Tribunal for Lebanon which was established by the United Nations Security Council to investigate the assassination of the former Lebanese Prime Minister, Rafiq Hariri, and a number of related assassinations and attempted assassinations.

In August 2011, he was appointed Deputy Commissioner, Field Operations, responsible for all six NSW Regions, the Major Events and Incidents Group, Traffic and Highway Patrol Command and the Police Transport Command.

Deputy Commissioner Kaldas was a Police (Hostage) Negotiator for over 10 years, achieving national Counter Terrorist level, and completed the F.B.I. Hostage Negotiators Course in Quantico, Virginia in 1996. He is a graduate of both the Leadership in Counter Terrorism Program (FBI-AIPM) and the Police Executive Leadership Program (AIPM). He is also a graduate and has been a Visiting Fellow of, the Management of Serious Crime Program (AFP). He has also completed the XXXIV Session of the FBI National Executive Institute. He holds a Masters Degree in Public Policy and Administration.

Deputy Commissioner Kaldas has been awarded 5 Commissioners' Commendations, the Australian Police Medal, the Humanitarian Overseas Service Medal, the National Medal and clasp, and the NSW Police Medal.



Det. Senior Constable Matt Taylor graduated from the Police Academy in May 2000 and commenced general duties. Over a 14 year career Matt has performed roles in General Duties, Highway Patrol, Proactive and Criminal Investigation duties in Target Action Groups, Region Enforcement Squads and Detective Offices. In 2006 he first began to relieve as a Supervising Sergeant in Criminal Investigation activities.

Matt's biggest achievement was in 2010 when he transferred into the State Crime Command Property Crime Squad Motor Unit. Combined with his experience as a Motor Mechanic and a Criminal Investigator, he has been involved in a number of Strike Force investigations that have received high praise including Strike Force Burindi and Strike Force Adderton. In 2012 Strike Force Burindi received the prestigious International Award of Merit at Kansas City, USA International IAATI Conference.

Matt's Detective designation was awarded on 31 December 2011. He presents regularly on vehicle theft and re-birthing trends to both internal and external stakeholders and is a current IAATI committee member. He



continues to work at the Motor Unit and assist in the prevention and detection of vehicle theft and re-birthing while he waits to be promoted to the rank of Sergeant.

Matt's presentation is titled "Strike Force ADDERTON Case Study". Strike Force ADDERTON which commenced in March 2012, was a Property Crime Squad, NSW Police Force, led investigation into a sophisticated organised criminal motor vehicle re-birthing syndicate which operated out of south west Sydney.



Chris Stott has been involved with DataDot Technology since its inception in 2000. Chris has worked in various capacities over that time including 2 years as Vice-President of DataDot USA, based in Seattle, and 2 years as CEO of DataDot Technology Australia. Chris is currently Executive Director and co-owner of DataDot Asia, based in Taipei, serving Asian markets including China.

For recreation, Chris enjoys flying aeroplanes and operates a flying school at Bathurst, NSW – Central West Flying.



Ben Kosic is President and CEO of Canadian National Insurance Crime Services (CANATICS). CANATICS, is a not-for-profit organization focused on using state-of-the-art analytical tools to identify potentially suspicious claims in insurance industry pooled data, to facilitate further investigation by individual insurers. By identifying these claims with participating insurers, CANATICS will provide insurance companies with an exciting new tool to aid in the investigation of insurance crime.

Past roles include: KPMG Canada Partner and Practice Lead for Business Intelligence and Data Analytics; and Partner, CIO & CFO of Chartwell Inc. Mr. Kosic is a results oriented leader with over 20 years of management and information technology consulting experience and track record of driving growth and delivery excellence. Mr. Kosic is also a Professional Engineer (P.Eng.) and a Certified Management Consultant



Dr Hugh McDermott is a leading Australian expert on Transnational Organised Crime and Criminal Justice.

Hugh is Barrister-at-Law, Senior Lecturer in Law Enforcement and the Director of the Anti-Money Laundering & Counter-Terrorist Financing, Fraud and Financial Crime Program at the Australian Graduate School of Policing and Security, Charles



Chris Loane has an extensive background in the Law and in investigations, having previously worked in the Queensland Courts, and the Queensland Police for almost 20 years, where he served as an Inspector from 1998.

Chris has been both a Barrister and a Solicitor in private practice in Queensland since leaving the Police in 2001. He holds a Master Of Insurance from Deakin University; a Bachelor of Arts from Griffith University; the Queensland Barristers Board Examinations with 2nd class Honours; Bar Practice Course at QUT, an Associate Diploma of Business Management and he has also undertaken a Diploma of Commercial Property Management. Chris is a Fellow of ANZIIF.

WISH YOU'D CHECKED YOUR USED CAR WAS LEGIT

Combating profit-motivated theft continues to be a primary focus of the National Motor Vehicle Theft Reduction Council (NMVTRC).

The NMVTRC places a strong emphasis on tackling the major structural weaknesses in our government and industry practices and policies that allow profit-motivated thieves to continue to ply their trade.

Our key strategies are aimed at disrupting the separated parts and vehicle laundering markets and include such initiatives as:

- implementation of new damage assessment criteria for the management of written-off vehicles (WOVs) to better meet the system's current and future needs;
- the establishment of Inter-agency Task Forces to gain new insights into the trade in separated parts; and
- continuing to promote better management of end-of-life vehicles for scrap metal purposes and export.

Ultimately, sustainable theft reduction requires action across a broad range of disciplines and our objectives can only be effective if supported by active and specialist vehicle theft investigation. The NMVTRC is proud to be a long time supporter of IAATI.

The NMVTRC is an initiative of Australian governments and the insurance industry. We strive to deliver the lowest rate of vehicle theft in the developed world.

Join the fight against vehicle crime by keeping in touch with the NMVTRC's many initiatives at www.carsafe.com.au



National Motor Vehicle
Theft Reduction Council



Chris previously worked for AAMI Insurance, where he held roles as the Manager of Insurance Investigations, Claims Administration Manager, and Business Administration Manager. Chris joined Suncorp in March 2008 as the Manager of Insurance Investigations. Chris is currently the National Motor Investigations Manager for the Suncorp Group.

Chris has presented at the National Public Sector Fraud & Corruption Seminar in Sydney in July 2012; the Queensland Conference of the Institute of Mercantile Agents (IMA) at the Gold Coast in October 2011, and at the National Conference of the IMA in Adelaide in April 2012. Chris has also presented at the IAATI New Zealand Seminar on auto theft held in Auckland New Zealand in October 2012 and at the Annual Australasian Seminar in 2013.



Laurie Ratz is Special Risks Manager, Insurance Council of Australia & the Insurance Fraud Bureau of Australia. He served 28 years in the Victoria Police including three years as a Chief Investigator with the National Crime Authority. In 1998 Laurie resigned with the rank of Detective Chief Inspector to manage the Loss Prevention, Corporate Security and Training portfolios of Qantas Group Security. In December 2007 he took up his current position with the Insurance Council of Australia as the Special Risks Manager and is the permanent Chair of the Insurance Fraud Bureau of Australia and responsible for the coordination of the general insurance industry's response to insurance fraud and crime prevention.

Laurie has a Post Graduate Degree in Criminology (Melbourne University) and an Advanced Certificate in Aviation Security (University of Western Sydney). He holds the National Medal and the Victoria Police Medal.



Joshua McAfee CEO of McAfee Institute (Top 1% of the Inc 500 Fastest Growing Companies & #1 in Education!). Joshua has spent most of his career in the asset protection, fraud, & cyber industries most recently as the CEO and Chairman of the McAfee Institute; one of the most notarized cyber-intelligence, fraud and leadership training organizations in the world.

Specialties: Internationally respected CEO on the Inc 500 Fastest Growing Companies in the World; eCrime & Cyber Crime expert, leadership coach, innovation extraordinaire, speaker, trainer, and author.

Joshua's presentation is titled "Introduction to Social Networking Investigation Methodologies". In this exciting 1 hour seminar you will examine some of the most innovative ideas, concepts and methodologies into conducting social networking investigations as they are introduced by the CEO of the McAfee Institute, Joshua McAfee and his team of industry experts which come from the world of eCommerce, loss prevention, law enforcement, and the intelligence community to bring you an action packed seminar that will leave you eager to return to work, to utilize your new found skill set.

- Learn How to Navigate the website, search, advanced search, sign-up, register a profile
- Learn about connections, friend's request, & privacy settings
- Learn How to Identify fraudsters, criminals, and illegal information Identify personal details, addresses, phone numbers, email address & more
- Learn how to bypass privacy settings, visualize seller networks and gather intelligence
- Learn How to Identify criminal activity and what is needed to prosecute
- Evidence gathering and chain of custody for digital evidence
- Legalities of online investigations, terms of service violations and subpoenas



Les Fuller, Maxim Forensic Locksmith Services. Les Fuller is one of Australia's foremost forensic locksmiths, providing expert forensic locksmith services to law enforcement and insurance clients around Australia. He started providing forensic locksmith services to the insurance industry in 1999 whilst working for his family locksmith business George Tall & Co, before starting Maxim Forensic Locksmith Services in 2004.

Les has been a member of IAATI since 2001, and in addition to providing expert forensic services he has also shared his knowledge through training presentations to assist in the education and development of his clients, as well as previous IAATI Australasian branch seminars.



Steve Clark is the global product manager for financial crime solutions for BAE Systems Applied Intelligence and he works with insurers across the globe to help protect their business and their customers from financial crime.

Steve is responsible for strategy and innovation of the multi-award winning NetReveal® insurance industry suite of solutions that help mitigate fraud and deliver tangible impact to insurers' bottom line. Steve has been involved in financial crime solutions for insurance, retail and commercial banking, healthcare and tax and has a Masters in Astrophysics from the University of St Andrews.



David Courtney, Courtney & Co Solicitors. David was admitted in 1985 and has extensive commercial litigation experience with particular emphasis on insurance fraud, banking, finance and insolvency. From 1985 to 2006 David was at Shaw McDonald and was, for many years that firm's Information Technology Partner. In that period he acted for numerous Australian and overseas insurers and a number of financial institutions and, in particular, the Commonwealth Bank and its associated entities.

Since 1 May 2006 David has been in practice at Courtenay & Co where he has continued to provide litigation and insolvency services advice to a number of clients including ORIX, the Proceeds of Crime Recovery unit of ITSA and for a time Allco. He has acted as contradictor in *cy pres* litigation and arrested a ship. He currently acts in fraud matters for AAI Limited subsidiaries namely GIO, AAMI, Suncorp, Shannons, APIA, Vero, Just Car. He holds a number of appointments as an investigator under section 267 of the Legal Profession Act (NSW) assists the Society upon conduct reviews and acts for the Council of the Society in appeals from Fidelity Fund rulings. He is a member of the Commercial Litigation Advisory Committee for the College of Law Masters Course.

David has published a number of articles including "The Innocent Mortgagee – Insurance Without Cost" concerning composite policies in the Australian Law Journal. He is an advocate of lawyers providing in house training and other add-on services which increase lawyer/client understanding and enable both to work together to a common goal.



Nigel Carson, Partner, KordaMentha. Nigel is responsible for the management and delivery of Forensic Technology services, including computer forensics and e-discovery, for KordaMentha in the Asia-Pacific.

Nigel has over 23 years' forensic investigative experience, including 18 years in the area of computer forensics. His early training was forged in the specialised technical investigations arm of the NSW



FACT IS STRANGER THAN FICTION

the little details
**ARE INFINITELY
THE MOST IMPORTANT**



CSI
CSI Investigations Pty Ltd

A boutique West Australian based factual investigations company delivering services to insurers and corporations.



Police Service supporting serious criminal investigations. He was previously practice head of computer forensics and electronic discovery at Ferrier Hodgson. Prior to that, Nigel was a computer forensic manager at KPMG and the first information technology security manager appointed for Coca Cola in Australia. Having started his career at the inception of computer forensics and worked in a diverse range of related jobs, Nigel is a seasoned professional in the field and often called upon to provide expert evidence in high profile cases. Nigel has worked extensively on intellectual property, piracy and workplace relations disputes and has recently been involved in a large number of electronic discovery assignments where he has pioneered the introduction of new technology into the Australian market.

Nigel's qualifications include:

Bachelor of Science in Computer Science and Applied Mathematics
 Certificate IV, Government (Investigation)
 Certificate III, Investigative Services
 Certificate in Computer Search and Recovery, Canada Revenue Agency
 Microsoft Certified Systems Engineer (MCSE)
 EnCase Certified Examiner (EnCE)

Nigel presentation is titled "Metadata and the art of digital investigation". This topic will talk broadly about the changes in the digital landscape of a world which is increasingly reliant on electronic devices, electronically stored information and cloud connectivity. Included in the discussion will be case studies and focus areas directly impacting insurance investigations such as:

- Analysing and interpreting digital metadata
- Photo forensics
- Smart phones and cloud synchronisation
- GPS tracking



Tim Myers has over 7 years' experience in the computer forensic investigation of corporate fraud and financial crime, intellectual property (IP) theft and contractual disputes across a wide variety of industries. This has included assisting investigations of law enforcement and regulatory bodies. Tim has assisted with the execution of a number of Anton Piller Orders and Search Warrants, including the identification, acquisition, seizure, and analysis of digital evidence.



Detective Sergeant Renee Kurtz has in excess of 13 years service within the Queensland Police Service and is currently attached to the Vehicle Crime Unit within the Drug and Serious Crime Group, State Crime Command, Brisbane. During her career, 12 years of which has been as a Detective, Detective Sergeant Kurtz has worked throughout Queensland and has a wide range of experience to draw from.



Malcolm Cumberlidge has over 30 years experience in the investigation and reconstruction of road traffic collisions. He served for 27 years in the London Metropolitan Police Traffic Department from 1982. He worked as a Forensic Collision Investigator in the Forensic Collision Investigation Unit investigating serious and fatal road traffic collisions. He retired in 2009 as a Sergeant and Senior Collision Investigator.



F.I.R.E.S.

Fire Investigation Risk & Enquiry Services Pty Ltd

Over 20 years experience
in fire origin and cause
investigation

POLICE & INSURANCE INDUSTRY BACKGROUND

Expert fire scene examination
of all types of fires including

- Structures
- Vehicles
- Plant & Machinery
- Heavy Transport
- Vessels

RISK AND HAZARD SURVEYS AND TRAINING

Excellent working knowledge
of Fire Safety Management &
Australian Standards

Mark Pollard

P: 08 83425871

F: 08 83425471

M: 0418841899

admin@fireinvestigation.com.au

www.fireinvestigation.com.au



Malcolm migrated with his family to Queensland in 2009. Since January 2010 Malcolm has worked in Australia as a consultant in Forensic Crash Investigation, for insurance companies and solicitors. Malcolm founded his own consultancy, Forensic Accident Investigation Services in September 2011. Malcolm is a member of the UK Institute of Traffic Accident Investigators and the Australian and South Pacific Association of Collision Investigators.



Detective Senior Constable Jason Henderson. Jason started his working career as an apprentice panel beater in 1988. He obtained his panel beaters trade certificate in 1991 and continued to work in the smash repair industry until he joined the NSW Police Force in 2002.

In August 2002 Jason attested from the Police College and was stationed at the Rosehill Local Area Command in General Duties. In 2005 he transferred to the Highway Patrol where he obtained experience in motor vehicle inspections and compliance.

In late 2007 Jason decided to pursue a criminal investigation career path and joined the South West Metropolitan Region Enforcement Squad where he investigated a variety of crimes.

In 2010 Jason transferred to the Property Crime Squad, Motor Unit to focus on organised motor vehicle related crime. He has investigated numerous motor vehicle re-birthing matters and his highlight so far is his involvement in Strike Force BURINDI, which was awarded the International IAATI Award of Merit in 2012.

Jason's presentation is titled "Strike Force GRANITE #104 Case Study". Strike Force GRANITE #104, was a NSW Police Property Crime Squad led investigation into the re-birthing and DataDot identification of a black Ford Tickford TS50.



Jim Manser has 26 years' experience in investigating vehicle and structure fires. Currently Jim works privately as a Forensic Fire Investigator in Western Australia. His experience as an Electrician, Part Time Fire Fighter and Crime Scene Investigator provides insights into the dangers of examining motor vehicles forensically. With the increasing popularity of electric vehicles the presentation at IAATI will include information about safely examining electric cars. Jim's presentation is titled "Investigating Vehicle Fires Safely".



Nick Mayell left school at the age of 16 and secured a position as an apprentice heavy vehicle mechanic with a local plant and truck company. He later went on to manage a hire company which is when he became brutally aware of the financial repercussions of heavy equipment theft. As more and more of his equipment became subjected to theft, he took it upon himself to trace and recover his own machines. Such was his success, insurance and finance companies continued to use his investigative skills to help locate their own assets.

In 1994 Nick was employed by a specialist heavy equipment investigation company in the UK and worked on many high profile cases, including one case which led to the recovery of 86 stolen machines. In 2011 he left to set up Plant Theft Consultancy. Nick's services are currently secured by the UK's leading asset marking and registration company, Datatag ID Ltd, who are the administrators the CESAR scheme.

Nick is a qualified trainer who regularly runs courses for Interpol's Formatrain project, he has also delivered courses for IAATI. His heavy equipment course is internationally recognised and accredited at level 3. He also runs a level 3 accredited courses in forensic vehicle VIN recovery, using both chemical and thermal techniques.



IAATI EXCLUSIVE OFFER:
 SAVE 30% OFF any Board Certification with McAfee Institute when you enroll by April 12th, 2014.

Creating influential leaders that deliver extraordinary results!



Certified Cyber Intelligence Professional (CCIP®) This certification designates individuals who have demonstrated competency in all areas of cyber intelligence, investigations & Management. It is the premier certification for cyber intelligence investigators and highly sought after.



Certified Cyber Intelligence Investigator (CCII®) Those individuals who hold the CCII® certification have demonstrated experience and/or education in the fields of cyber investigation management, evidence collection, case presentation.



Certified Organized Retail Crime Investigator (CORCI®) The CORCI credential denotes proven expertise in organized retail crime prevention (ORC), detection and prosecution. It's the industries most applicable, re-world, & practical training in ORC.



Certified Human Trafficking Investigator (CHTI®) designation is awarded to Human Trafficking practitioners who have proven expertise and proficiency in human trafficking investigation management, intelligence gathering, digital evidence collection, interview and interrogation, developing reports and testimony to validate findings.



McAfee Institute Certified Trainers (MICTs) are the premier anti-fraud and instructional experts in McAfee Institute Training Courses. Join this exclusive group of McAfee Institute anti-fraud & cyber training professionals and reap the benefits of certification & membership.



ENROLL NOW: 888-263-1650
training@mcafeeinstitute.com
<http://www.mcafeeinstitute.com>



Auto Theft Certification Program

The Australasian Branch of the International Association of Auto Theft Investigators has established a Certification program for members. The Branch has partnered with a Registered Training Organisation (RTO) Maurice J Kerrigan & Associates Pty Ltd as an independent assessment body to review applications against the Auto Theft Certification program competencies.

Members can now have their knowledge, expertise and qualifications acknowledged by taking part in the Australasian Branch's accreditation program. The certification program is available to IAATI members working in the fields of law enforcement such as Investigations, Intelligence, and Forensics, members from the insurance industry such as Licensed Investigators, Claims Officers or Claims Assessors, members working for Government Authorities and Regulators and members that are Technical Specialists.

Details of the Certification Program and the Certification Kits can be downloaded from the RTO's web site www.kerrigans.com.au. Go to the web site and click on the training tab. Applicants need to register their details to access the applications under 'Products and Services' on the Kerrigans Training Portal.

For more information about the accreditation program email your questions to accreditation@iaatiaus.org

Book your Auto Theft Certification Assessment by emailing training@kerrigans.com.au.

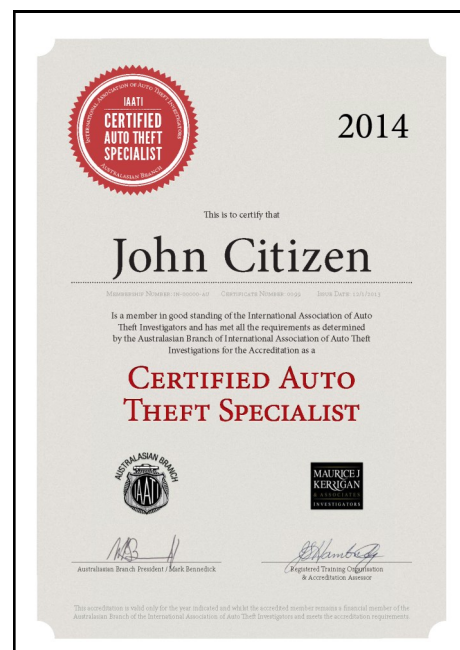



Seminar Supporters

The Australasian Branch acknowledges that not all companies are able to become major sponsors. As such we gratefully appreciate the support for all our partners both large and small. Please support those companies and individuals who are assisting the Australasian Branch to continue to service its members.



AUSTRALIAN GRADUATE SCHOOL OF POLICING AND SECURITY

Postgraduate studies in:

- ANTI-MONEY LAUNDERING
- CORRUPTION AND INTEGRITY MANAGEMENT
- EMERGENCY MANAGEMENT
- FIRE INVESTIGATION
- FRAUD AND FINANCIAL CRIME
- INTELLIGENCE ANALYSIS
- INVESTIGATIONS
- LEADERSHIP AND MANAGEMENT (POLICING AND SECURITY)
- MBA (LAW ENFORCEMENT AND SECURITY)
- POLICING AND SECURITY
- TERRORISM AND SECURITY STUDIES

1800 334 733 | www.csu.edu.au

YOU + CSU



Seminar Supporters



KIM WILSON
National Manager



PO Box 271
Sumner Park BC QLD 4074



Phone: 1300 079 112
Mob: 0416 285 707
Fax: (07) 3376 6046

Email: btstranscription@bigpond.com
Website: www.btstranscriptionservices.com.au

Malcolm Cumberlidge

FORENSIC COLLISION ANALYST

 info@fais55.com.au  0438 227 556

 www.fais55.com.au  P.O. Box 55
Palmwoods
Queensland, 4555

***Forensic Accident
Investigation Services***



Seminar Supporters

Courtenay & Co Solicitors

David Courtenay

100A Longueville Road, Lane Cove
Ph: 02 9420 1622 Fax: 02 9420 1655 Mobile: 0400 60 40 84
david@courtenayco.com.au



Dr Hugh McDermott

PhD (Laws)
Senior Lecturer in Law
Enforcement
Course Director - AML-CTF,
Fraud & Financial Crime Pro-
grams Barrister-at-Law (NSW)
(Inner Temple, England & Wales)

www.csu.edu.au
CRICOS Provider Number for Charles Sturt University is 00006F.

**AUSTRALIAN GRADUATE
SCHOOL OF POLICING AND
SECURITY**

FACULTY OF ARTS

P O Box 168
Manly NSW 1655

Collins Beach Road
Manly NSW 2095
Australia

Tel: +61 2 9934 4782
Email: hmcdermott@csu.edu.au



Before you go, don't forget ...

To complete the upcoming Member Survey

In the next two weeks you will be receiving a questionnaire in your in-box which seeks your feedback about the Association. The online questionnaire will take 10–15 minutes to complete and we appreciate your assistance, so we can tailor the Association to better meet your needs.

Not receiving your APB, VIN or E-news?

If you are a financial member and have not received copies of the VIN, APB or E-News please contact us at info@iaatiaus.org to ensure we have your correct email and postal address. Email is the primary means of communication with our members so please ensure you keep us informed of any changes.

Consider submitting a newsletter article

Remember the only way IAATI members can benefit is via the sharing of information. So why not consider writing a short article for one of our newsletters (VIN, APB or E-news). It doesn't need to be long and can be a short summary of an investigation, a book or product review, a funny story or photograph, or your review of the seminar. All material for the VIN, APB or E-News can be sent to the editor at info@iaatiaus.org

Nominate for an Award

In today's fast pace world we are all so busy that we seldom have the time to acknowledge the excellent and innovative things that are happening around us. So why not take a few minutes to brag about yourself or a colleague and nominate for an award. You can nominate at any time for one or more of the Branch or International Awards. The 2014 International Awards close 1st May and the 2015 Australasian Branch Awards will close in January 2015.

Become IAATI Certified in your field of expertise

Remember you can have your knowledge, expertise and qualifications acknowledged by taking part in the Australasian Branch's certification program. The certification program is available to IAATI members working in the fields of law enforcement such as Investigations, Intelligence, and Forensics, members from the insurance industry such as Licensed Investigators, Claims Officer or Claims Assessors, members working for Government Authorities and Regulators and members that are Technical Specialists. Go to www.iaatiaus.org or contact John Hambridge at john.hambridge@kerrigans.com.au for more information.

The 62nd International Training Seminar in Texas, USA

Consider joining a group of fellow Australasian Branch members who will be attending this year's five day International Training Seminar in Fort Worth, Texas, USA, 17—22 August. For further information about the seminar visit the IAATI International website www.iaati.org or contact the seminar director via seminar@iaati.org

The most important thing

Remember to make use of IAATI. Visit our websites regularly and make use of the information and contacts you have developed throughout this seminar. You will find that IAATI members throughout the world are generally very willing to help fellow IAATI members whenever they can. Like most things in life, the more you get involved, the more you will get out of the Association.

Finally,

Thank you for attending this Training Seminar in Sydney. Have a safe journey home and we hope to see you again next year.

